



STAINLESS STEEL

FLOOR TROUGHS & FLOOR DRAINS

Floor Troughs

4" Depth

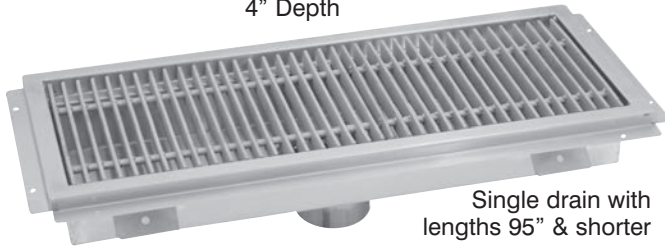

Single drain with lengths 95" & shorter

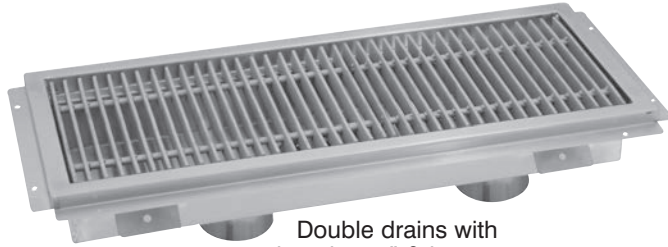

Double drains with lengths 96" & longer



Item #: _____ Qty #: _____

Model #: _____

Project #: _____



Cut-Out View of Anti-Splash

FT-1
Optional Anti-Splash Guard
(Per ft. Factory installed)

Floor Drain

4" Depth

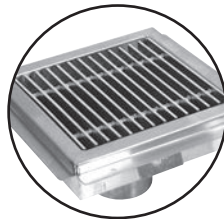

FD-1
Optional Stainless Steel
Grate for Floor Drains



FT-2
Stainless Steel Strainer Basket
with Handle (Included with all Floor Troughs,
Water Receptacles & Floor Drains)

Floor Water Receptacles

2" Depth

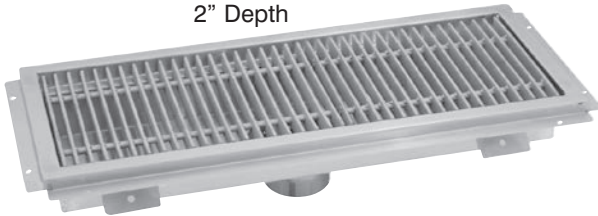

OPTIONAL ACCESSORIES

Model #	Qty
FT-1 Anti-Splash Guard per ft.	
FT-2 Replacement Strainer Basket	
FD-1 Floor Drain Stainless Steel Grate	

FEATURES:

- Waste receptacle will accommodate up to a 4" waste pipe.
- Includes 4" O.D. - 3" Long Plumbing Sleeve.
- Removable perforated stainless steel strainer basket with handle provided.
- Pitched towards waste.
- Includes "Subway Style" grating from 3/16" x 1" solid "304" stainless steel bar or fiberglass. (Not included with Floor Drains. Use Model FD-1)
- Grating is spaced 9/16" (Inside clearance) between bars to prevent casters from getting trapped.
- Troughs 96" or larger in length made with two (2) drains.
- Custom sizes available. Consult factory.

CONSTRUCTION:

- All TIG welded.
- All external corners welded and polished to a satin finish.

MECHANICAL:

- Creased design to ensure proper drainage.
- Perimeter flange mounts directly to sub floor.
- 3/4" vertical step designed to accommodate floor tile installation.

MATERIAL:

- 14 gauge "304" type stainless steel polished stainless steel grating.
- Fiberglass grating: Gray fiberglass composite. Light weight, skid and corrosion resistant.



Customer Service Available To Assist You **1-800-645-3166** 8:30 am - 8:00 pm E.S.T.

For Orders & Customer Service:

Email: customer@advancetabco.com or Fax: 631-242-6900

For Smart Fabrication™ Quotes:

Email: smartfab@advancetabco.com or Fax: 631-586-2933

DIMENSIONS and SPECIFICATIONS

ALL DIMENSIONS ARE TYPICAL

TOL ± .500"

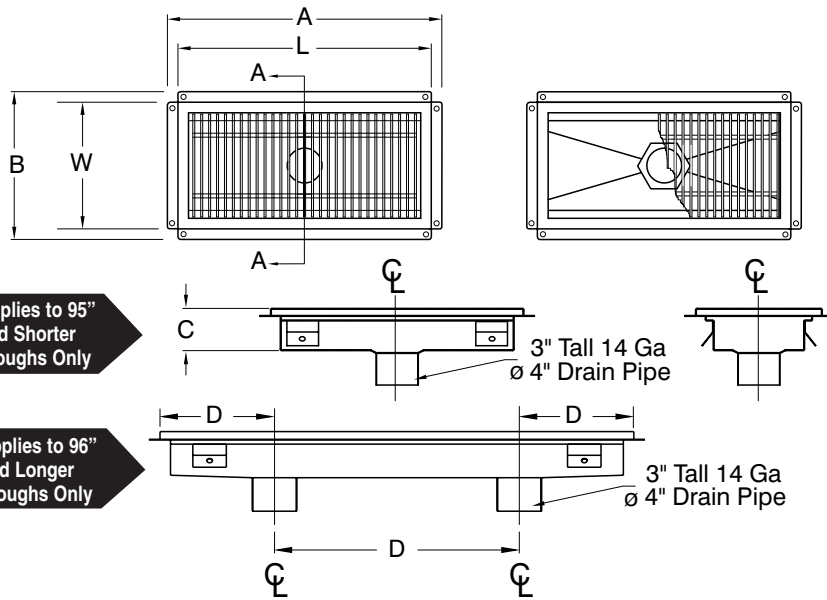

Applies to 95" and Shorter Troughs Only

Applies to 96" and Longer Troughs Only

FLOOR TROUGHS

Stainless Steel Grating	Wt.	Fiberglass Grating	Wt.	L	W	A	B	C	D
FTG-1224	46 lbs.	FFTG-1224	34 lbs.	24"	12"	26"	14"	4"	-
FTG-1230	56 lbs.	FFTG-1230	37 lbs.	30"	12"	32"	14"	4"	-
FTG-1236	66 lbs.	FFTG-1236	40 lbs.	36"	12"	38"	14"	4"	-
FTG-1242	76 lbs.	FFTG-1242	43 lbs.	42"	12"	44"	14"	4"	-
FTG-1248	86 lbs.	FFTG-1248	46 lbs.	48"	12"	50"	14"	4"	-
FTG-1254	96 lbs.	FFTG-1254	49 lbs.	54"	12"	56"	14"	4"	-
FTG-1260	106 lbs.	FFTG-1260	52 lbs.	60"	12"	62"	14"	4"	-
FTG-1272	116 lbs.	FFTG-1272	55 lbs.	72"	12"	74"	14"	4"	-
FTG-1284	126 lbs.	FFTG-1284	81 lbs.	84"	12"	86"	14"	4"	-
FTG-1296*	146 lbs.	FFTG-1296	90 lbs.	96"	12"	98"	14"	4"	32"
FTG-12108*	166 lbs.	FFTG-12108	99 lbs.	108"	12"	110"	14"	4"	36"
FTG-12120*	180 lbs.	FFTG-12120	108 lbs.	120"	12"	122"	14"	4"	40"
FTG-1824	62 lbs.	FFTG-1824	43 lbs.	24"	18"	26"	20"	4"	-
FTG-1830	74 lbs.	FFTG-1830	47 lbs.	30"	18"	32"	20"	4"	-
FTG-1836	86 lbs.	FFTG-1836	54 lbs.	36"	18"	38"	20"	4"	-
FTG-1842	98 lbs.	FFTG-1842	61 lbs.	42"	18"	44"	20"	4"	-
FTG-1848	110 lbs.	FFTG-1848	69 lbs.	48"	18"	50"	20"	4"	-
FTG-1854	122 lbs.	FFTG-1854	76 lbs.	54"	18"	56"	20"	4"	-
FTG-1860	134 lbs.	FFTG-1860	83 lbs.	60"	18"	62"	20"	4"	-
FTG-1872	146 lbs.	FFTG-1872	90 lbs.	72"	18"	74"	20"	4"	-
FTG-1884	165 lbs.	FFTG-1884	111 lbs.	84"	18"	86"	20"	4"	-
FTG-1896*	187 lbs.	FFTG-1896	125 lbs.	96"	18"	98"	20"	4"	32"
FTG-18108*	208 lbs.	FFTG-18108	138 lbs.	108"	18"	110"	20"	4"	36"
FTG-18120*	229 lbs.	FFTG-18120	150 lbs.	120"	18"	122"	20"	4"	40"
FTG-2424	69 lbs.	FFTG-2424	52 lbs.	24"	24"	26"	26"	4"	-
FTG-2430	81 lbs.	FFTG-2430	59 lbs.	30"	24"	32"	26"	4"	-
FTG-2436	104 lbs.	FFTG-2436	68 lbs.	36"	24"	38"	26"	4"	-
FTG-2442	118 lbs.	FFTG-2442	75 lbs.	42"	24"	44"	26"	4"	-
FTG-2448	131 lbs.	FFTG-2448	83 lbs.	48"	24"	50"	26"	4"	-
FTG-2454	145 lbs.	FFTG-2454	95 lbs.	54"	24"	56"	26"	4"	-
FTG-2460	162 lbs.	FFTG-2460	102 lbs.	60"	24"	62"	26"	4"	-
FTG-2472	195 lbs.	FFTG-2472	119 lbs.	72"	24"	74"	26"	4"	-
FTG-2484	218 lbs.	FFTG-2484	137 lbs.	84"	24"	86"	26"	4"	-
FTG-2496*	243 lbs.	FFTG-2496	153 lbs.	96"	24"	98"	26"	4"	32"
FTG-24108*	274 lbs.	FFTG-24108	168 lbs.	108"	24"	110"	26"	4"	36"
FTG-24120*	310 lbs.	FFTG-24120	188 lbs.	120"	24"	122"	26"	4"	40"

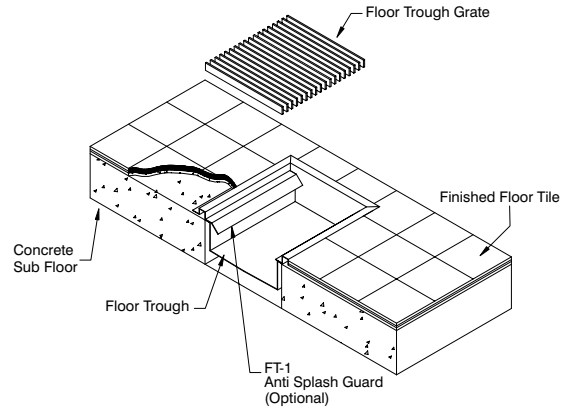
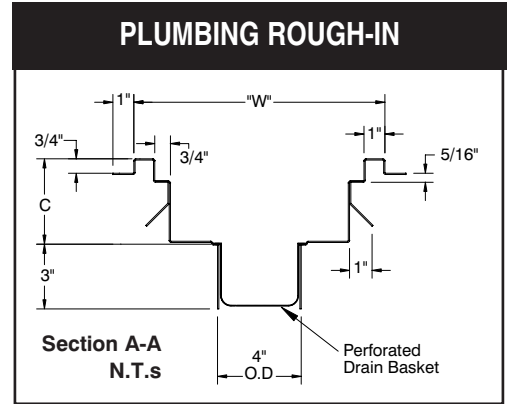

FLOOR DRAINS

Model #	Length	Width	A	B	C	Wt.
FDR-1212	12"	12"	14"	14"	4"	26 lbs.

FLOOR WATER RECEPTACLES

(2" Depth)

Model #	Length	Width	A	B	C	Wt.
FRG-24	24"	12"	26"	14"	2"	44 lbs.
FRG-36	36"	12"	38"	14"	2"	63 lbs.
FRG-48	48"	12"	50"	14"	2"	82 lbs.

CUSTOM SIZES AVAILABLE!

*Troughs 96" or larger in length made with two (2) drains.

