

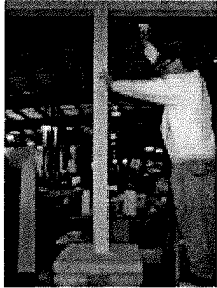

24 River Road • Bogota, NJ 07603

Craftsman Series Column Installation of Non-Tapered Columns

Warning: precision machined edges of Poly-Classic Craftsman column components can be extremely sharp. Use of appropriate personal protection equipment is required.



1) Measure overall opening from floor to beam or soffit (must have structural pressure-treated post or lally column for load support.)

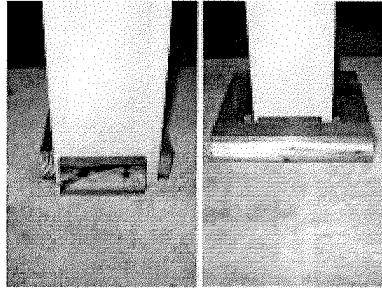

2) Install blocking around load bearing post (use pressure treated lumber.) Final width of blocking must be same width as inside of column.

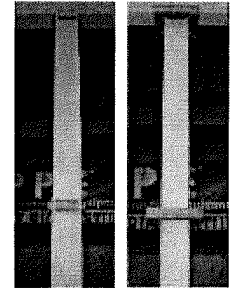

3) Install blocking around center and top of post to match step 2. (Center blocking is optional.) Blocking may be attached to deck/soffit instead of post if necessary.

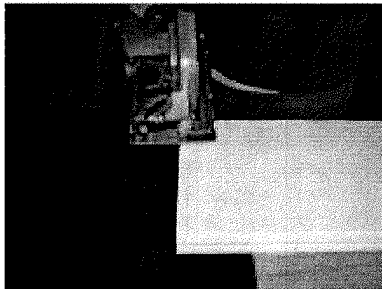

4) Trim shaft pieces at least 1/4" shorter than opening height (from step 1). Trim ONLY from bottom - top end is marked.



5) If you are going to use screws, pre-drill/countersink all panels. See joint diagram on next page to determine which edge to pre-drill.

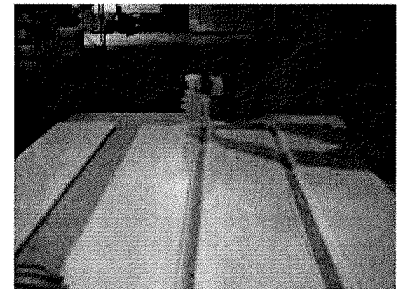

6) Lay 3 panels flat and apply adhesive to center joints. (Polyurethane glue is recommended. Follow manufacturers instructions.)

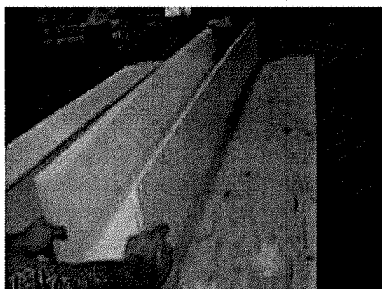

7) Assemble three panels, using E-Z lock joints.

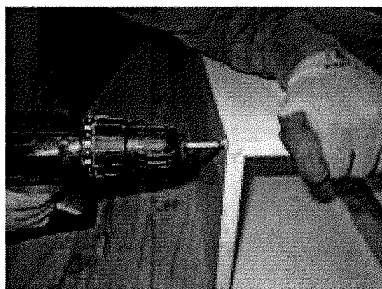

8) If using screws, assemble three panels together using coarse thread galvanized screws (deck screws.)



9) Or if you are not using screws, finish nail three panels together.

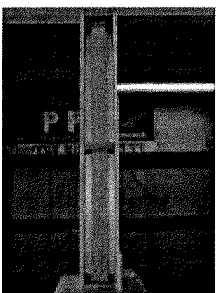

10) Place the partially assembled (3 panels) column around post and blocking.



11) Apply adhesive to final panel and attach to shaft using E-Z Lock joints.

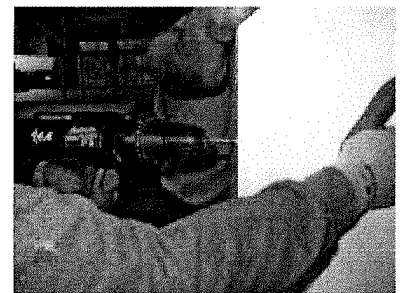

12) Screw or nail final panel in place.



13) Screw or nail column to blocking **ONLY ON THE BOTTOM**. Do not attach at center or top (to allow for expansion.)



14) Apply adhesive to mitered ends of base moulding (9¼" tall) and assemble around bottom of column shaft.

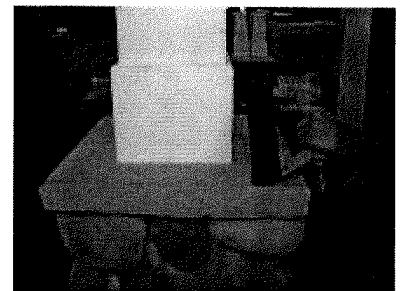

15) Fasten joints on base with screws or nails.

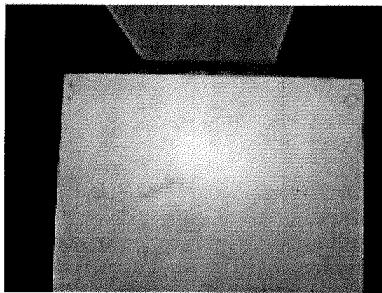

16) The TOP of the shaft should NOT be fastened to the blocking, and there should be at least ¼" gap to allow for expansion (see step 4.)

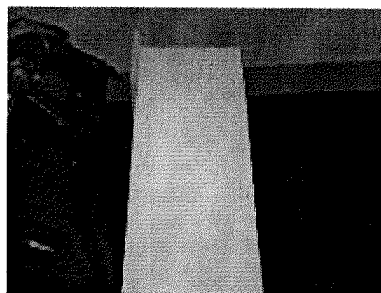

17) There are TWO methods of attaching the cap. First, apply adhesive to mitered ends of cap moulding (7¼" tall) and assemble around shaft. Screw or nail joints.



18) Option 1: attach cap to soffit with construction adhesive and toenail to soffit. **DO NOT ATTACH** cap to column shaft if the cap is flush with soffit (allows expansion.)*



19) Option 2: Leave ¼" expansion room above cap, and pin-nail the cap to the column. Be sure pin-nails **DO NOT** reach the blocking inside!*

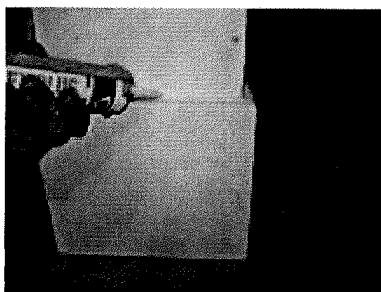

20) Caulk edges of base, cap, and nail or screw holes.



21) Clean surface of column with cleaner recommended by the paint manufacturer. Paint with 2 coats of acrylic latex paint.

E-Z Lock Joint Assembly:

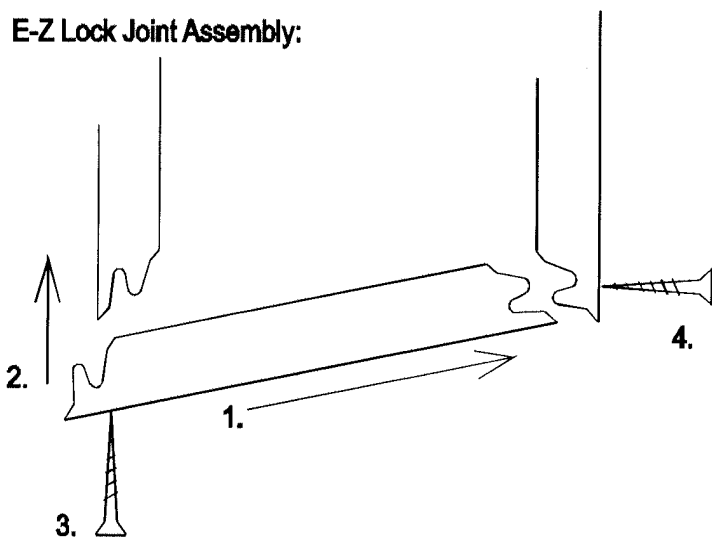

Please note the correct assembly of the E-Z Lock joint shown at the left. The screws or nails **MUST** be installed only in the edges shown (3 and 4). Installing on the other edges may result in open seams. (Pre-drill if using screws.)

- 1) Glue both joint edges; slide 1st joint together
- 2) Push 2nd joint closed
- 3) Nail or screw this joint first
- 4) Nail or screw this joint second.

Notes:

Panels are marked "TOP" - trim from the bottom only. Cap and base pieces are also marked as "CAP" or "BASE". Only use non-corrosive fasteners - galvanized, stainless steel, etc. Always follow glue and paint manufacturer's instructions.

*Column must not be allowed to collect water, debris, etc. If the top of the column extends beyond the soffit/beam, the cap must be flashed with lead, copper, aluminum, etc. to prevent accumulation.